

ДЕНЬ 1. ЗАДАНИЕ 1. «Вырезаем и подписываем фигурки Жирафика и Журавля»

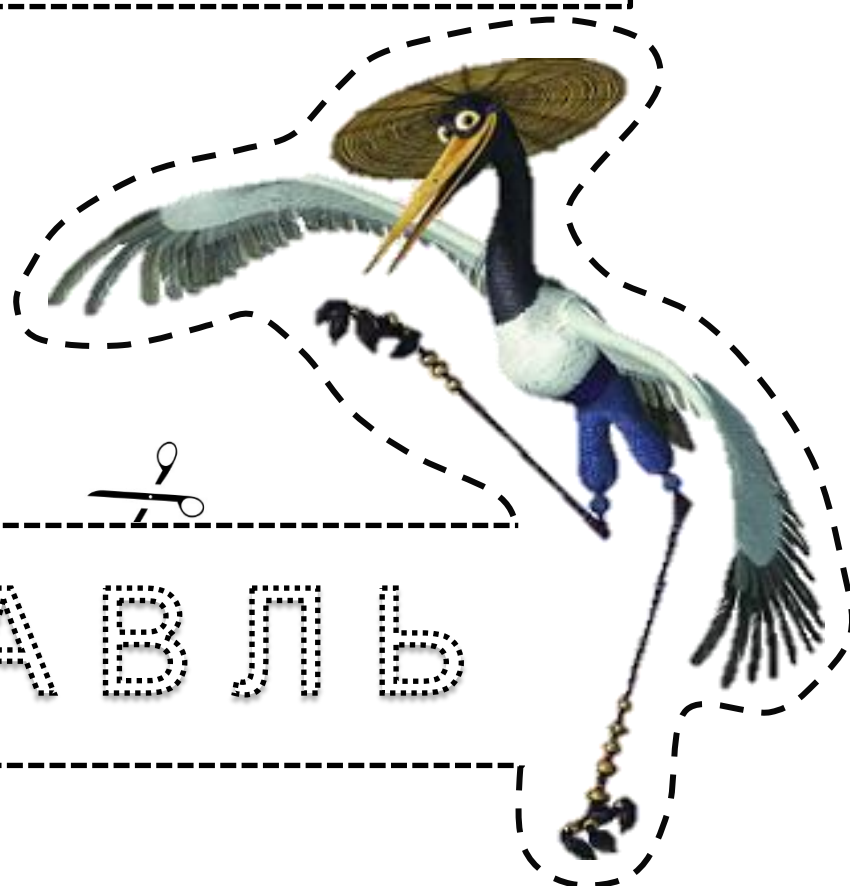

ЖИРАФ



ЖУРАВЛЬ

«СТРОИМ С ЖИРАФИКОМ КОРАБЛИК»
Схема создания кораблика из листа формата А4

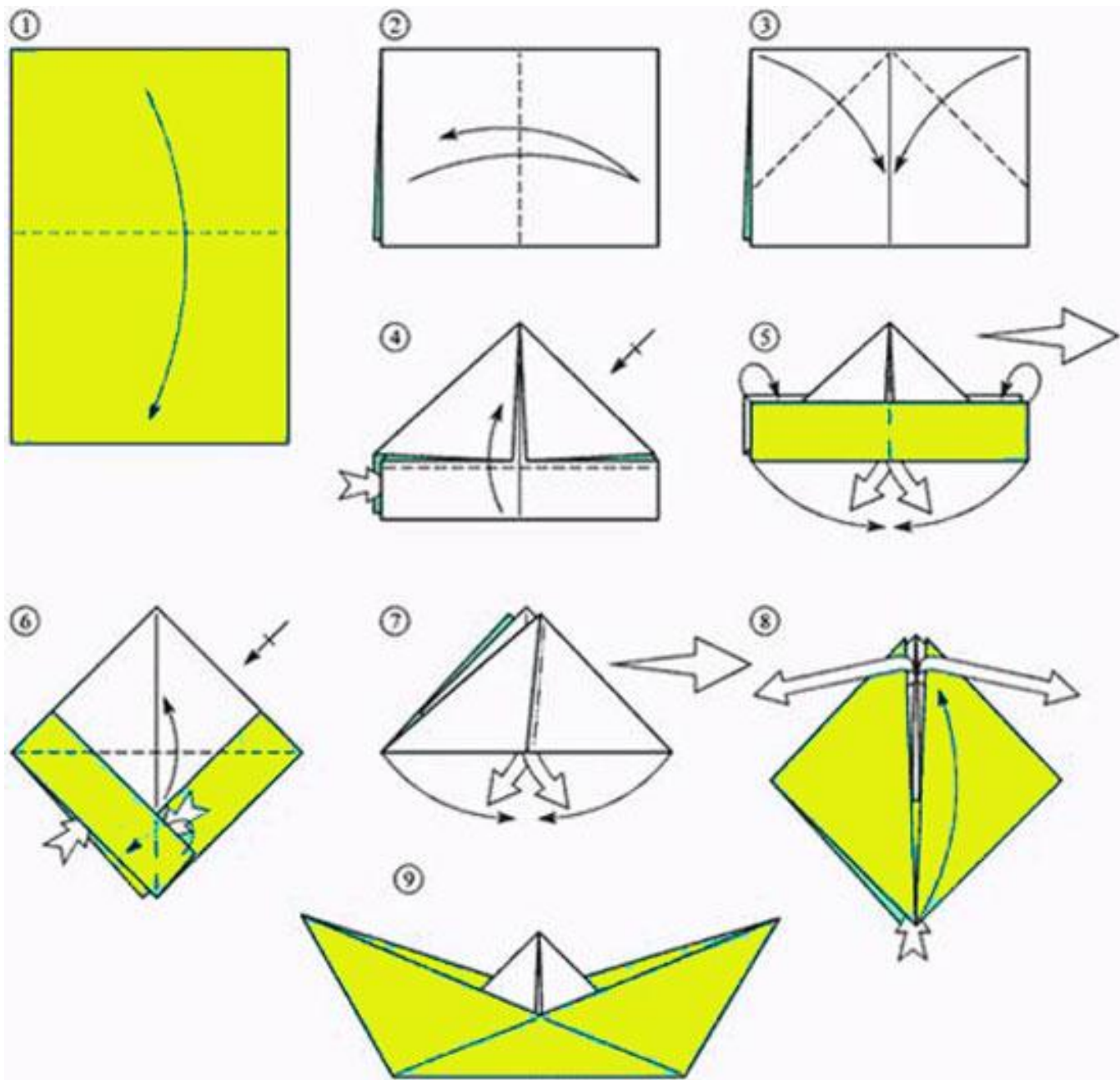

ГОЛОВА

ТЕЛО

НОГИ

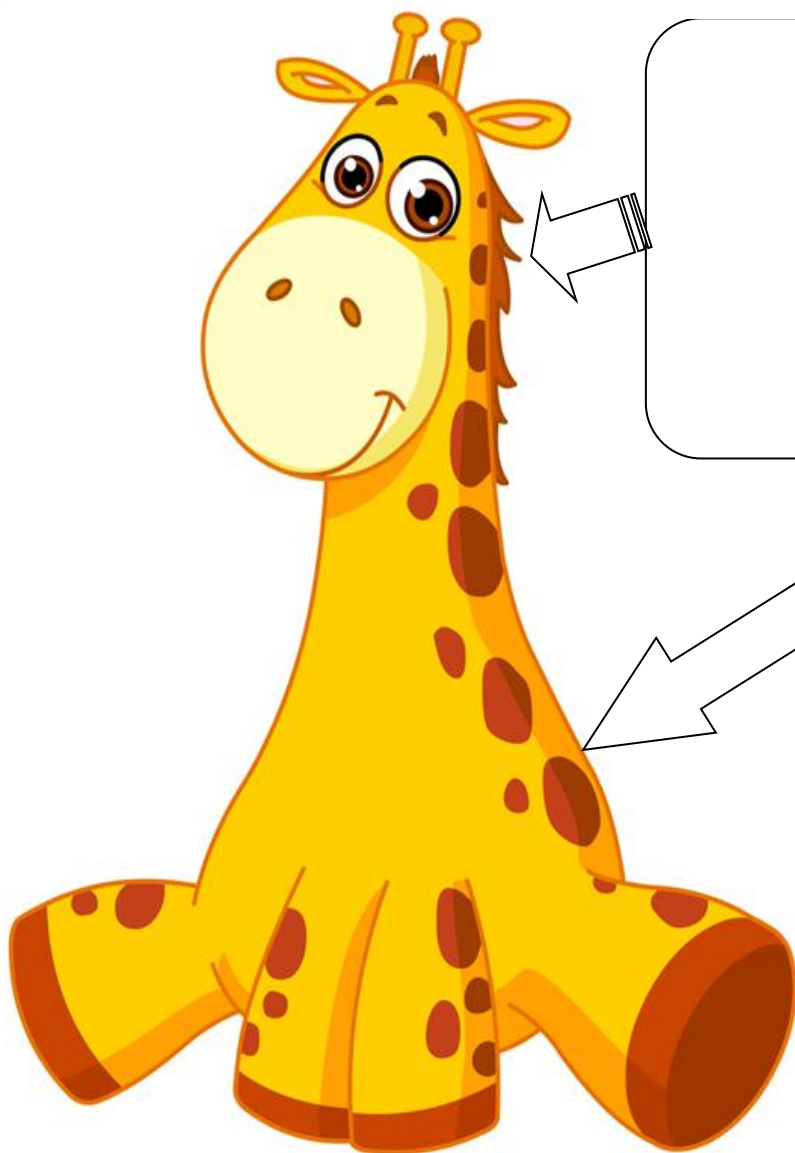

ПЕРЧАТКИ



КЕПКА



КУПАЛЬНИК



ШАПКА



ФУТБОЛКА



БОТИНКИ



**САПОГИ
РЕЗИНОВЫЕ**



СВИТЕР



БОСОНОЖКИ



ВАРЕЖКИ



ПОДСНЕЖНИК



ПОДСНЕЖНИК



КРОКУС



МОРОЗНИК



МОРОЗНИК



КРОКУС



МЕДУНИЦА



МЕДУНИЦА



НАРЦИСС



ФИАЛКА



ФИАЛКА





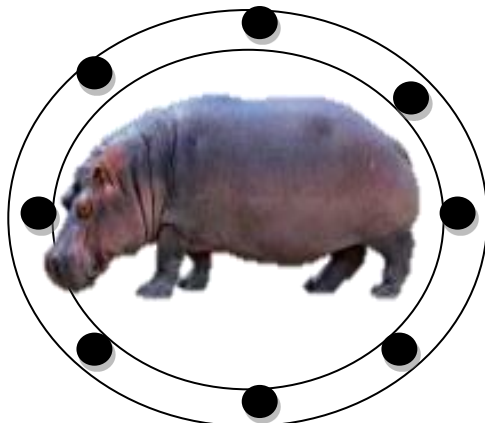
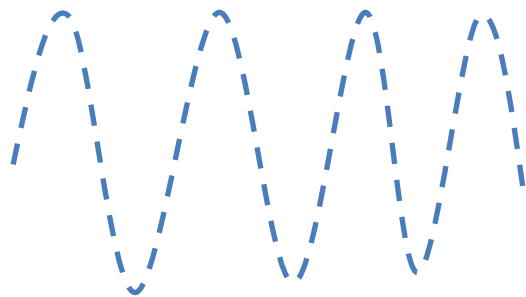
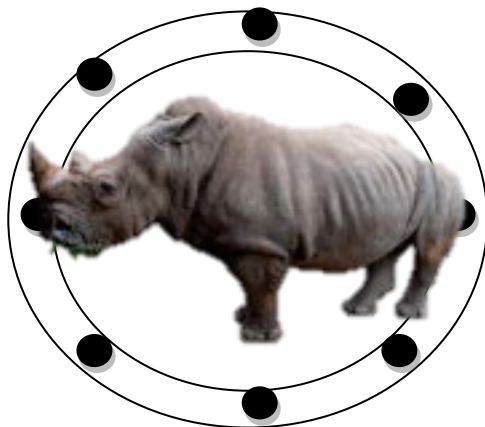
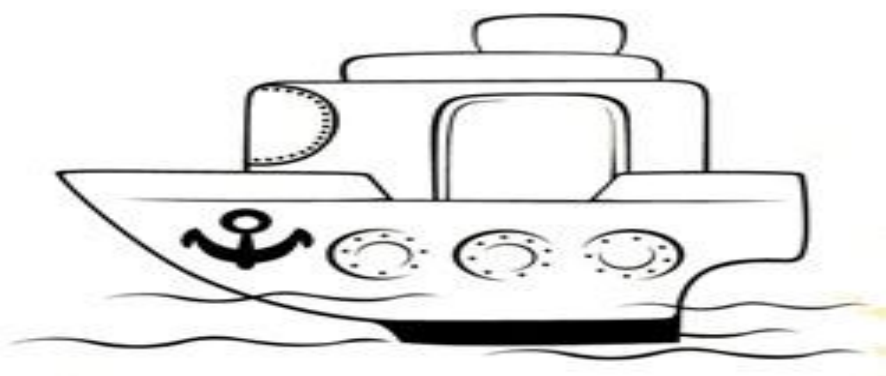

НАРЦИСС

ДЕНЬ 1. ЗАДАНИЕ 4. ИГРА «Помоги малышам попасть в каюту к родителям»

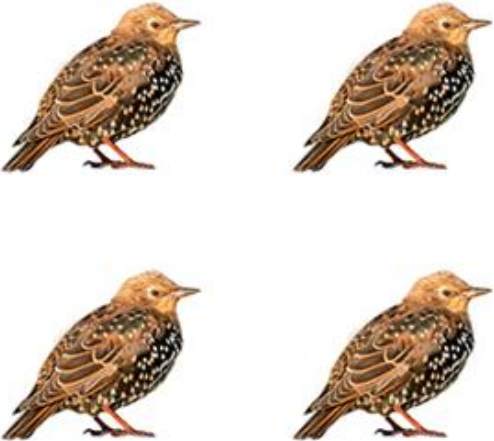

ДЕНЬ 1. ЗАДАНИЕ 5 Научи Жирафика считать

					
5	8	2	3	1	7
					
1	4	6	4	9	2



7

2

10

5

6

2



7

1

3

5

8

3